

# DO it

We thought of you!



ORIGINE  
FRANCE®  
GARANTIE

BVCert. 6164725

# ERARD®

# FiXiT

Technical details

10 YEAR  
GUARANTEE

## FiXiT 200

- Fixed mount for 19" - 32" screens
- Tested up to 150 kg

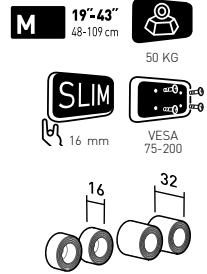
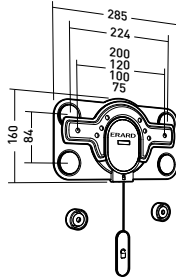
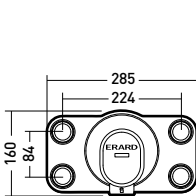

## FiXiT 400

- Fixed mount for 30" - 55" screens
- Tested up to 200 kg

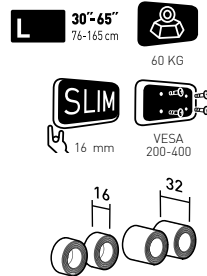
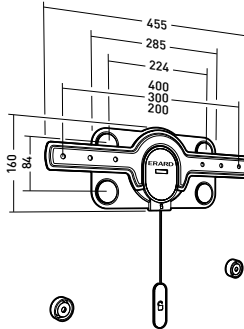
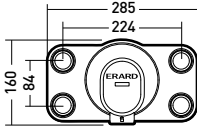

## FiXiT 600

- Fixed mount for 40" - 75" screens
- Tested up to 280 kg

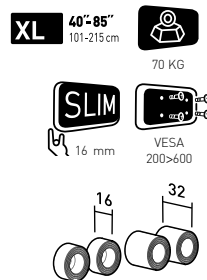
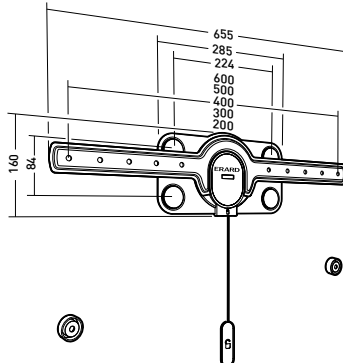
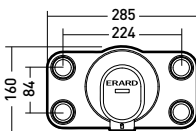



# TiLTiT / TWiSTiT

Technical details

## TiLTiT 400

- Tilting mount for 30" - 55" screens
- Tested up to 120 kg

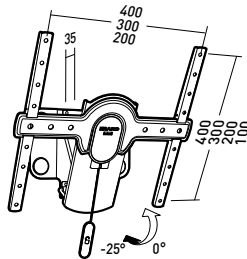
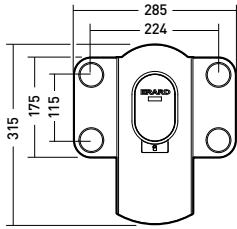

30 KG



0°-25°



VESA 200-400



35 mm



MAX THICKNESS 50 mm

## TWiSTiT 400

- Tilting and swivelling mount for 30" - 55" screens
- Tested up to 120 kg

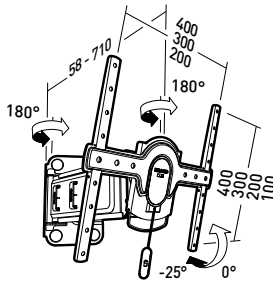
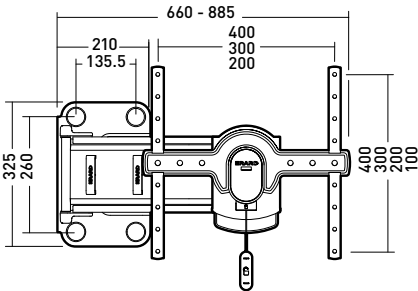

30 KG



0°-25°



VESA 200-400



-90° > +90°



58 mm



MAX THICKNESS 50 mm

Adjustable arm with integrated ruler

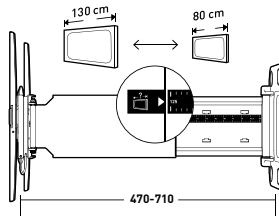

Telescopic arm



CORNER INSTALLATION POSSIBLE

# DO iT Range

Complete range for flat screens

**M** 19"-43"  
48-109 cm

**L** 30"-65"  
76-165 cm

**XL** 40"-85"  
101-215 cm

19" 30" 40" 43" 65" 85"

**TWISTIT 400**  
TILTING  
AND SWIVELLING



044440

**TILTIT 400**  
TILTING



044240

**FIXIT**  
FIXED



044020



044040



044060

## ERARD®

ESSENTIAL ACCESSORIES  
FOR AUDIO VIDEO COMPONENTS

Mail : [export@erard.fr](mailto:export@erard.fr) / [www.erard.com](http://www.erard.com) / Tel : +33 (0)4 72 46 16 26 / Fax : +33 (0)4 72 46 16 22

VAT N°: FR 81 403 591 415

Z.I. de Chavanoz / 4 route de la Plaine / 338230 CHAVANOZ / FRANCE

